



Figure 1. Physical Photo of AIDC5V5V200MATH

FEATURES

- Output Voltage Proportional to Input Voltage
- High Isolation Voltage: 1500VDC
- Input Voltage Range: 4.5V ~ 5.5V
- Max. Output Current: 200mA
- High Efficiency: 77% @ $V_{IN} = 5V$ & $I_{OUT} = 200mA$
- Switching Frequency: 220kHz
- Compact SIP package
- Wide Operating Temperature Range: $-40^{\circ}C \sim 85^{\circ}C$

APPLICATIONS

Isolated DC-DC converter modules are electronic devices that convert a DC input into a DC output voltage proportional to the input voltage value with galvanic isolation between the input and output circuits. Our newly developed power supply module, AIDC5V5V200MATH, is designed to have a high isolation voltage capability, 1500V, at an efficiency of up to 77%. Here are some common applications of isolated DC-DC converter modules:

1. Power supplies for telecommunications and networking equipment: Isolated DC-DC converter modules are commonly used to power telecom and networking equipment, such as routers, switches, and

base stations. They provide high efficiency and reliability in a compact form factor, making them ideal for use in these applications.

2. Industrial automation and control systems: Isolated DC-DC converter modules are used in a wide range of industrial automation and control systems, such as robotics, process control, and factory automation. They provide reliable and stable power to sensitive control circuits and sensors.

3. Medical devices: Isolated DC-DC converter modules are used in various medical devices, such as patient monitoring systems, infusion pumps, and imaging equipment. They offer reliable and efficient power conversion while providing safety and protection to patients and medical staff.

4. Renewable energy systems: Isolated DC-DC converter modules are used in renewable energy systems, such as solar power and wind power systems, to convert the DC output from the renewable energy source to a regulated DC voltage suitable for charging batteries or powering electronic devices.

5. Automotive electronics: Isolated DC-DC converter modules are used in automotive electronics, such as infotainment systems, powertrain control modules, and advanced driver assistance systems. They provide reliable and efficient power conversion in the harsh automotive environment, where high temperatures and voltage spikes are common.

Overall, isolated DC-DC converter modules are used in various applications where reliable, efficient, and regulated power conversion is required with galvanic isolation between the input and output circuits.

This product line offers a variety of input and output voltages, its full families are shown in Table 4. on page 5.



DESCRIPTION AND SPECIFICATIONS

Our power supply unit is designed to withstand extreme temperatures, with a wide operating range of -40°C to $+85^{\circ}\text{C}$. This makes it a versatile and reliable choice for use in a variety of industrial and commercial settings. With a mean time between failure of 35×10^5 hours (equivalent to 400 years of continuous use), you can trust that it will keep your equipment running smoothly for years to come.

Table 1. Pin Names AND Functions.

No.	Name	Type	Description
1	GND	Power Ground	Negative Input Voltage
2	VIN+	Power Input	Positive Input Voltage
3	VOU-	Power Output	Negative Output Voltage
4	VOU+	Power Output	Positive Output Voltage

Table 2. Specifications

INPUT						
Parameter	Symbol	Test Conditions	Min.	Typ.	Max.	Unit/Note
Input Voltage	V_{IN}		4.5	5.0	5.5	V
Input Current	I_{IN}	Full Load		239		mA
		No Load		17		mA
Surge Voltage (1sec. max.)			-0.7		9	VDC
Filter			Capacitor			
OUTPUT						
Parameter	Symbol	Test Conditions	Min.	Typ.	Max.	Unit/Note
Output Power	P		0.1		1	W
Output Voltage	V_{OUT}		4.5		5	V
Output Current	I_{OUT}				200	mA
Output Voltage Accuracy			See Figure 2 and Figure 3			
Line Regulation	$\Delta V_{OUT}/\Delta V_{VPS}$	Input voltage change: $\pm 1\%$	-1.2		1.2	%
Load Regulation	$\Delta V_{OUT}/\Delta I_{OUT}$	Load change from 10% to 100%	-15		15	%
Ripple & Noise		Full Load Bandwidth = 20MHz		75	100	mV _{p-p}
Capacitive Load					470	μF



Efficiency	η		76		80	%
Temperature Coefficient		Full Load	-0.03		0.03	%/°C
Short Circuit Protection			Continuous, self-recovery (The AIDC24V24V42MATH lacks short circuit protection)			

GENERAL CHARACTERISTIC

Parameter	Symbol	Test Conditions	Min.	Typ.	Max.	Unit/Note
Isolation Voltage	V_{IS}	$t_{test} = 60s, I_L \leq 0.5mA$		1500		VDC
Isolation Capacitance		100kHz/0.1V		20		pF
Isolation Resistance				1000		MΩ
Switching Frequency	f_{SW}			220		kHz
Operating Temperature Range	T_{opr}		-40		85	°C
Storage Temperature Range	T_{stg}		-55		125	°C
Case Temperature Rise	T_{cr}	$T_A = 25^\circ C$		25		°C
Pin Soldering Temperature		The distance between the solder joint and the case is 1.5mm, for 10 second.			300	°C
Storage Relative Humidity Range	RH		5		95	%
Mean Time Between Failure	MTBF	MIL-HDBK-217F@25°C		35×10^5		Hrs
Case Material			Black thermoplastic UL94V-0			
Weight				1.4		g
				0.003		lbs
				0.049		Oz



TYPICAL PERFORMANCE CHARACTERISTICS

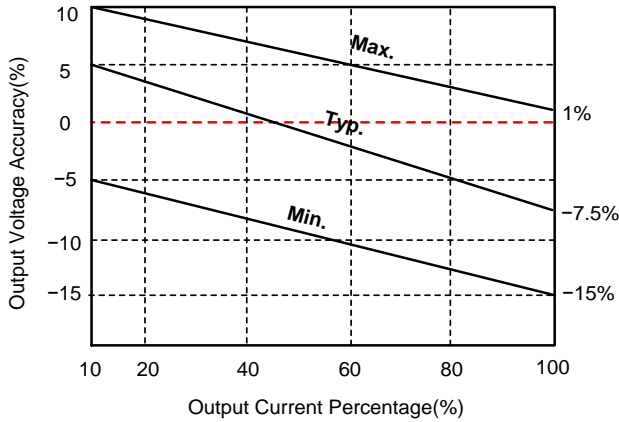

Figure 2. Load vs. Output Voltage ($V_{IN}=3.3V$)

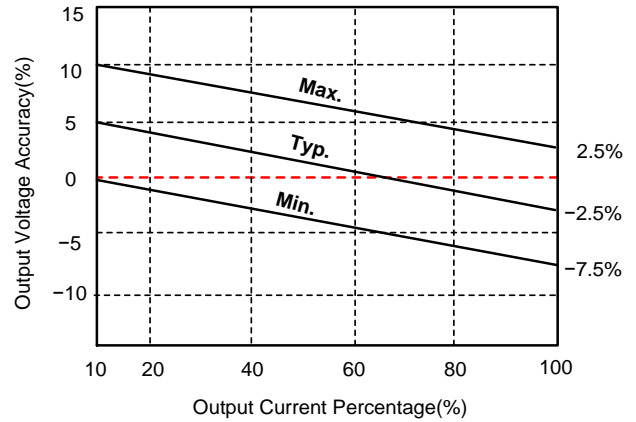

Figure 3. Load vs. Output Voltage

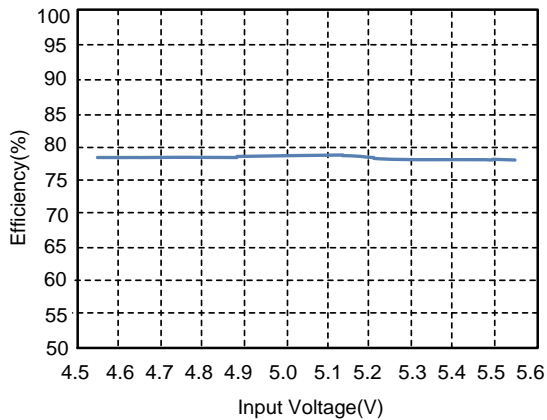

Figure 4. Input Voltage vs. Efficiency (Full Load)

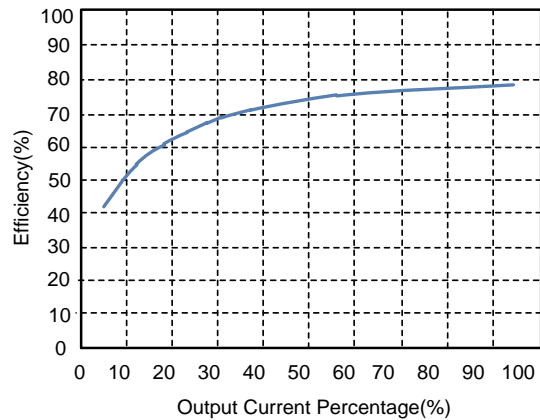

Figure 5. Load vs. Efficiency ($V_{IN} = 5V$)

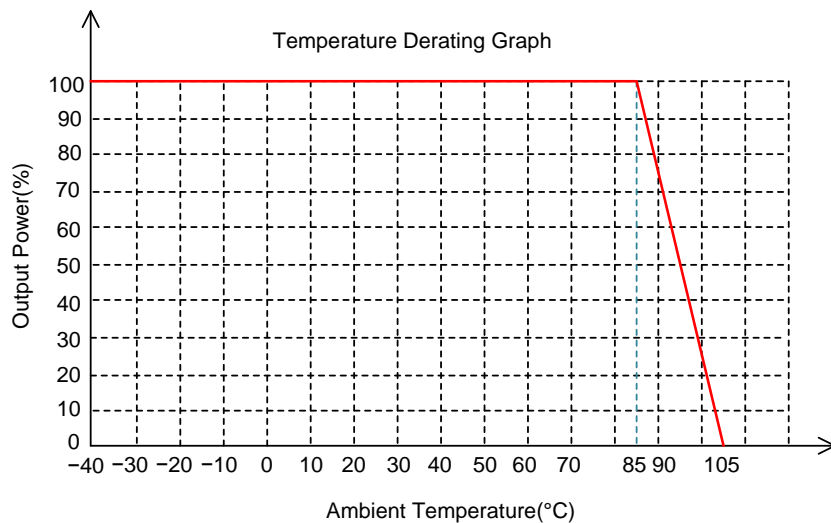

Figure 6. Derating Curve



TYPICAL APPLICATIONS

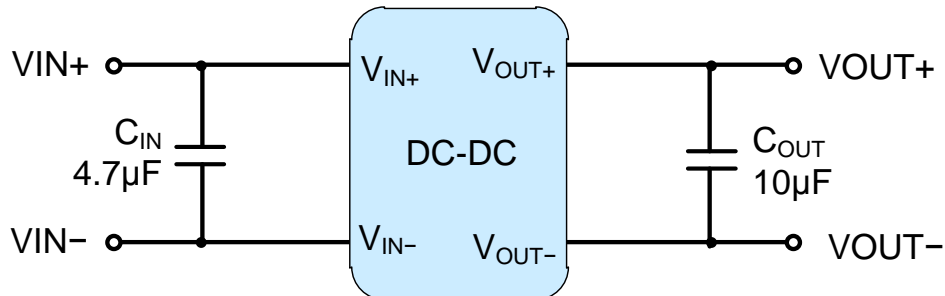

Figure 7. Recommended Circuit

The simplest way to use AIDC5V5V200MATH is shown in Figure 7, where C_{IN} can be 4.7µF and C_{OUT} 10µF. Choose a low ESR capacitor, such as MLCC (Multi-Layer Ceramic Capacitor) type, with appropriate voltage ratings.

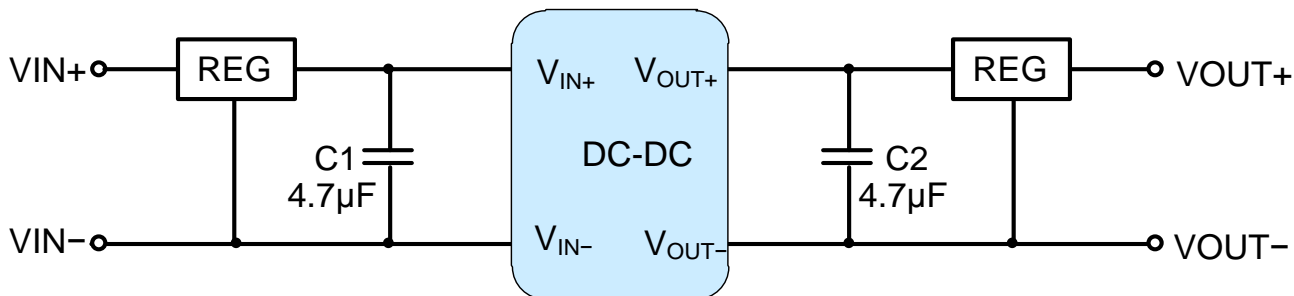

Figure 8. Output Voltage Regulator and Overvoltage Protection Circuit

1. Parallel usage and hot-swapping are not supported by this product.
2. To ensure that the power module operates efficiently and reliably, it is recommended that the minimum load not be less than 10% of the rated resistive load. If the required power is lower than this, it is advised to connect a resistor at the output end that is equivalent to 10% of the rated load.
3. The maximum capacitive load of the product is based on the rated full-load test, and should not be exceeded when in use. Otherwise, it may cause difficulties in starting and damage the product.



OUTLINE DIMENSIONS

Through Hole Package (TH)

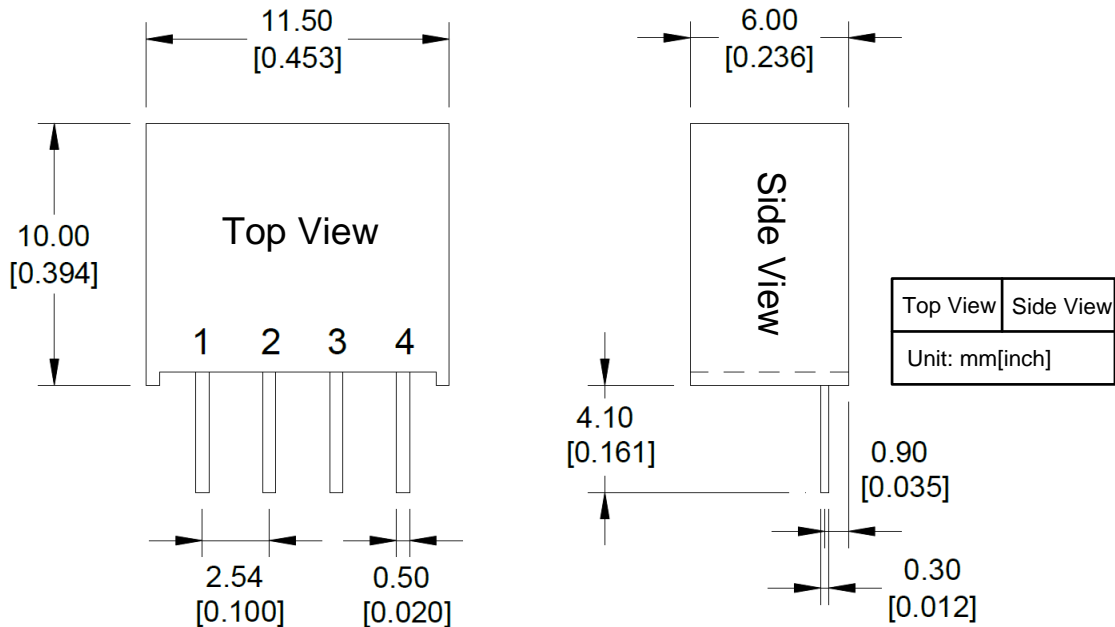

ORDERING INFORMATION

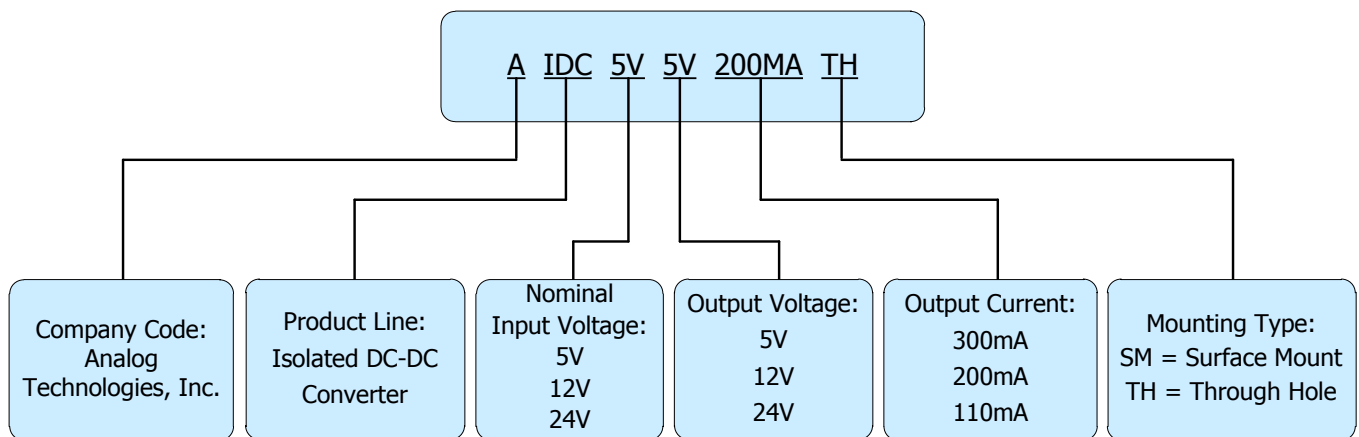

Figure 9. Naming Convention of AIDC5V5V200MATH

Part Number	Buy Now
AIDC5V5V200MATH	* *

*: both and are our online store icons. Our products can be ordered from either one of them with the same pricing and delivery time.



Table 4. AIDC5V5V200MATH Families with Different VIN

Product Model	Input Voltage		Output Voltage V	Output Current mA	Input Current (mA)		MAX. Capacitive Load μF	Ripple & Noise mV _{p-p}	Efficiency (%)	
	Typ.	Range			Full Load	No Load			Min.	Typ.
AIDC3V3V300MATH	3.3	2.97~3.63	3.3	303	404	30	220	150	68	72
AIDC3V5V200MATH			5	200	404	30	220	150	72	76
AIDC3V12V83MATH			12	83	347	45	470	150	76	80
AIDC5V3V300MATH	5	4.5~5.5	3.3	300	277	25	470	150	68	72
AIDC5V5V200MATH			5	200	239	17	470	150	76	80
AIDC5V9V110MATH			9	110	277	20	470	150	76	80
AIDC5V12V83MATH			12	83	277	20	470	150	76	80
AIDC5V15V67MATH			15	67	277	20	470	150	76	80
AIDC5V24V42MATH			24	42	277	20	470	150	76	80
AIDC12V3V300MATH	12	10.8~13.2	3.3	300	116	15	470	150	68	72
AIDC12V5V200MATH			5	200	101	11	470	150	76	80
AIDC12V9V110MATH			9	110	108	15	470	150	76	80
AIDC12V12V83MATH			12	83	101	16	470	150	76	80
AIDC12V15V67MATH			15	67	99	13	470	150	76	80
AIDC12V24V42MATH			24	42	115	15	470	150	76	80
AIDC15V5V200MATH	15	13.5~16.5	5	200	82	10	470	150	76	80
AIDC15V12V83MATH			12	83	82	12	470	150	76	80
AIDC15V15V67MATH			15	67	82	10	470	150	85	87
AIDC24V3V300MATH	24	21.6~26.4	3.3	300	57	7	470	150	68	72
AIDC24V5V200MATH			5	200	48	7	470	150	79	83
AIDC24V9V110MATH			9	110	57	7	470	150	76	80

*Note: See Figure 9.



NOTICE

1. ATI warrants its products to perform according to specifications for one year from the date of sale, except when damaged due to excessive abuse. If a product fails to meet specifications within one year of the sale, it can be exchanged free of charge.
2. ATI reserves the right to make changes or discontinue products or services without notice. Customers are advised to obtain the latest information before placing orders.
3. All products are sold subject to terms and conditions of sale, including those pertaining to warranty, patent infringement, and limitation of liability. Customers are responsible for their applications using ATI products, and ATI assumes no liability for applications assistance or customer product design.
4. ATI does not grant any license, either express or implied, under any patent right, copyright, mask work right, or other intellectual property right of ATI.
5. ATI's publication of information regarding third-party products or services does not constitute approval, warranty, or endorsement.
6. ATI retains ownership of all rights for special technologies, techniques, and designs for its products and projects, as well as any modifications, improvements, and inventions made by ATI.